

0.5B1-LT-nPF

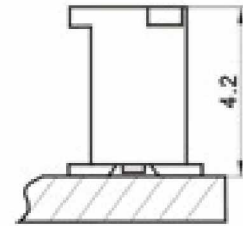

安装图
ASSEMBLY LAYOUT

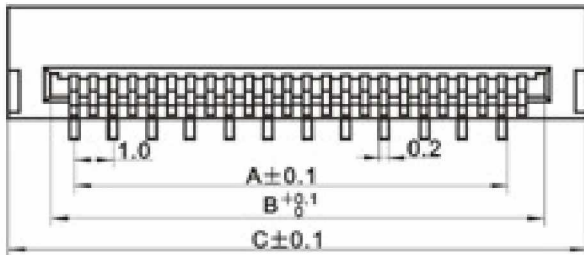
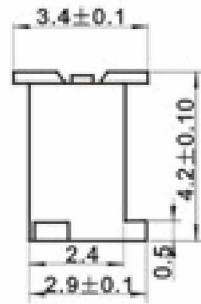
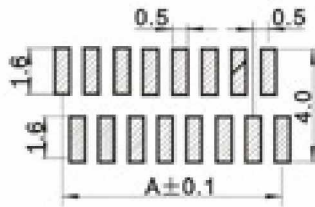

反针 PCB 寸法
Versa needle PCB LAYOUT

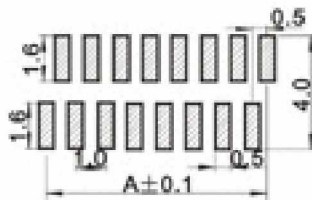

正针 PCB 寸法
Positive needle PCB LAYOUT

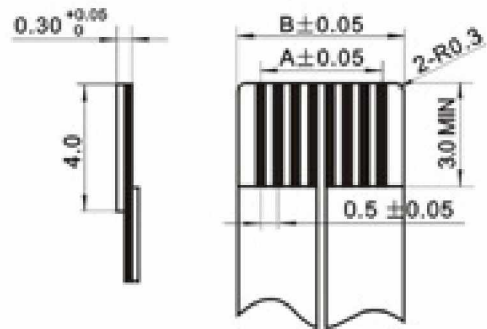

适用扁平电缆
Proper cable

0.5B1-LT-nPF

- 间距 (Pitch) _____
- 型号:(Model) _____
- 立式:L _____
- Vertical pype:L _____
- 贴式:T _____
- SMT:T _____
- 线数 (Hole location) _____
- 反针:F(正针无) _____

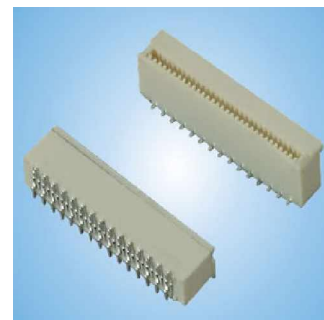

Yueqing sunrising electronic co.,ltd
Tel: 0086-13634204680
<http://www.china-electrical-supplier.com>
master@china-electrical-supplier.com