

1.0B-L-nPF

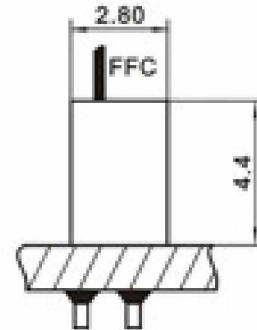

安装图
ASSEMBLY LAYOUT

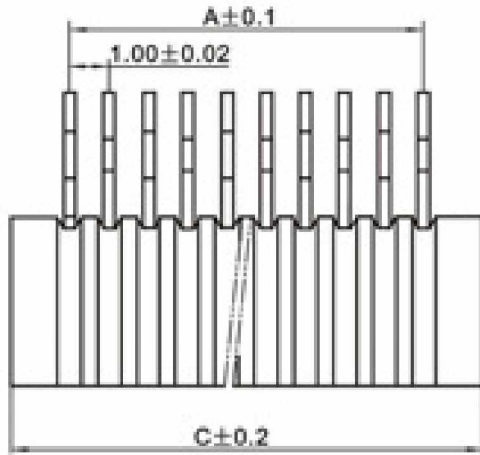
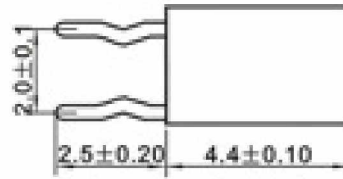
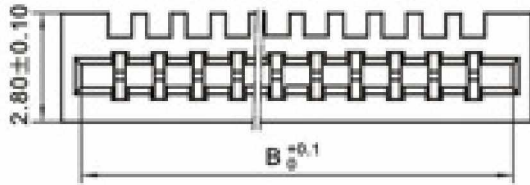
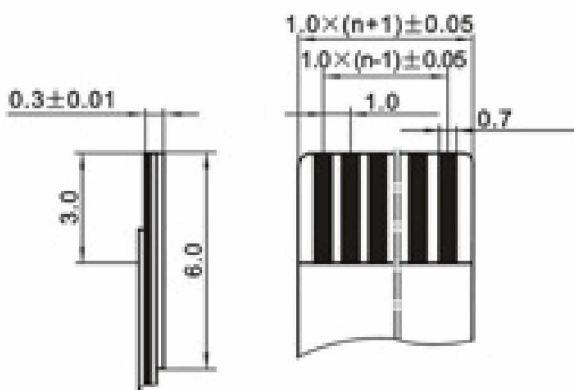

适用扁平电缆
Proper cable

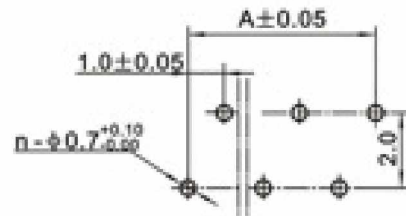

正针 PCB 寸法
Positive needle PCB LAYOUT

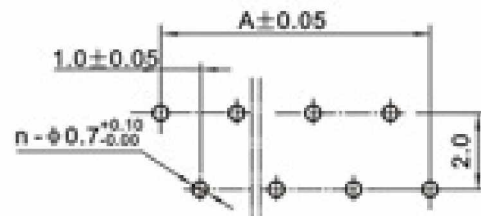

反针 PCB 寸法
Versa needle PCB LAYOUT

1.0B-L-nPF

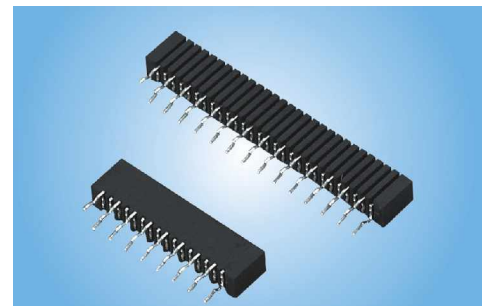
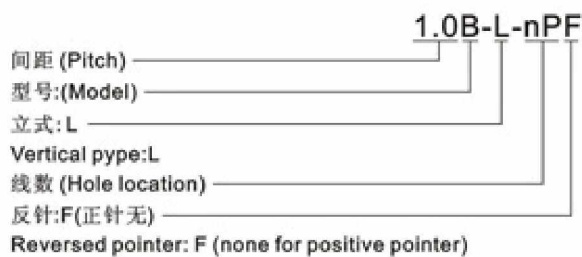

Yueqing sunrising electronic co.,ltd
Tel: 0086-13634204680
<http://www.china-electrical-supplier.com>
master@china-electrical-supplier.com